

## 32/35 SERIES

- PRESSFIT INDICATOR LIGHTS
- NEON, LED & INCANDESCENT
- 2 TO 600 DESIGN VOLTS
- 6" WIRE LEADS & 3/16" TAB TERMINALS
- VARIETY OF LENS COLORS
- UL AND CSA LISTED • UL FILE E20356
- CSA FILE LR15284-5

### Overview

The 32/35 Series Indicators feature a wide variety of lenses, colors, voltage & bezel variations. Indicators quickly pressfit into a 0.500" to 0.510" mounting hole with recommended panel thickness range of 0.020" min. to 0.090" max. A speednut, part number **8700071674**, and Adapters for 0.514" to 0.519" are available.

### Specifications

**Housing:** white nylon. A black housing is available.

**Bezel:** nickel plated brass. A black anodized bezel is available.

**Lens:** polycarbonate.

**Incandescent AC or DC voltage options:** 6, 14 and 28 volts.

**Neon AC or DC voltage options:** 125, 250 and 600 volts. **Note:** high brightness green and blue neon lamps supplied in green and blue neon applications.

**LED DC voltage options:** 2, 6, 12, 24 volts.

**LED AC voltage options:** 125 volts.

**Note:** 125 volts AC units contain a bi-polar LED.

**Two 6" wire leads:** #20 AWG, black, bare copper, PVC insulated, UL/CSA rated 105°C, 600 V, UL style 1015, stripped 1/2". For DC LED units, wire leads are color-coded red and black; the red wire lead denotes the anode (+) while a black wire lead identifies the cathode (-). For AC LED units, wire leads are white. Custom wire lengths, stripping, termination and wire types are available.

#### Terminals:

**3/16" tabs:** brass, (0.187" length x 0.020" thick). For LED units, a tin plated terminal denotes the anode (+). 1/4" or 1/8" brass tab terminals are available.

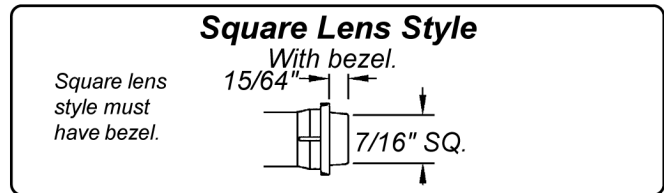
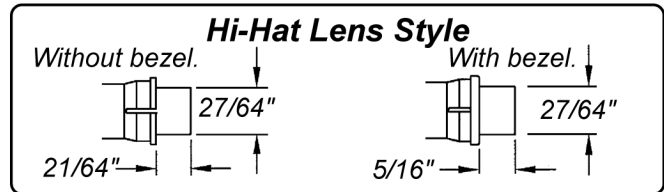
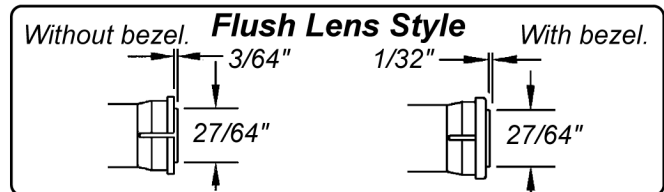
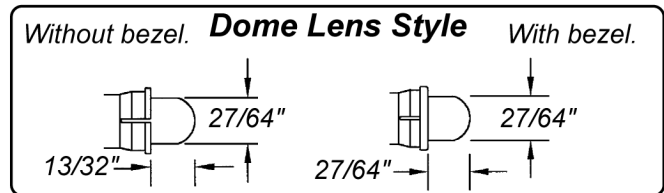
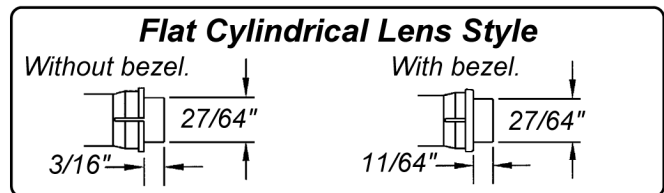
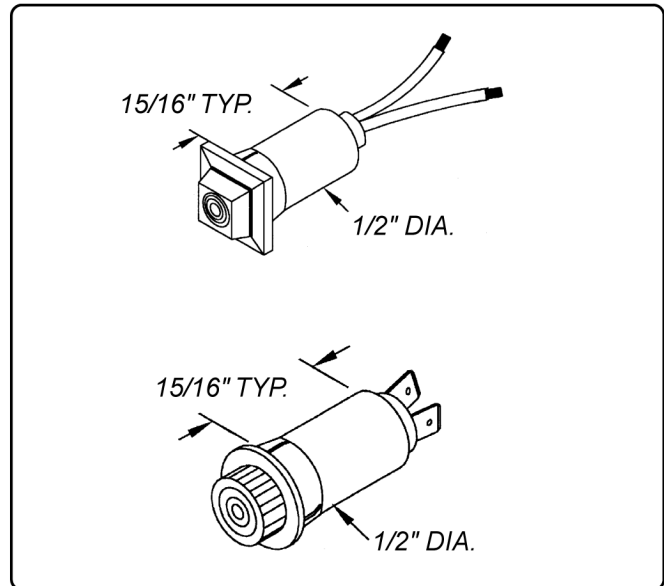



**PRESSFIT INDICATOR LIGHTS  
FOR 1/2" DIA. MOUNTING HOLE**



**32/35 Series  
Flat Cylindrical Lens  
Without Bezel  
Neon or  
Incandescent**

**Flat Cylindrical Lens Style**  
*Without bezel.*

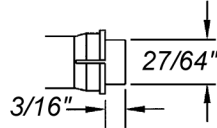

**6" Wire Leads or  
3/16" Tab Terminals  
White Housing  
6 to 250 Design Volts  
PressFit Mounting**

Part Number 6" Wire Leads	Part Number 3/16" Tab Terminals	Lens Color	Lamp Type	Design Volts	Design Watts or Amps	Life (hrs)
32-2111	32-2111T	Red	Neon	125	1/3W	25,000
35-2111	35-2111T	Red	Neon	250	1/3W	25,000
32G1-2111	32G1-2111T	Red	Incandescent	6	.20A	5,000
32G3-2111	32G3-2111T	Red	Incandescent	14	.10A	10,000
32G18-2111	32G18-2111T	Red	Incandescent	28	.04A	7,000
32-2112	32-2112T	Green	Neon	125	1/3W	25,000
35-2112	35-2112T	Green	Neon	250	1/3W	25,000
32G1-2112	32G1-2112T	Green	Incandescent	6	.20A	5,000
32G3-2112	32G3-2112T	Green	Incandescent	14	.10A	10,000
32G18-2112	32G18-2112T	Green	Incandescent	28	.04A	7,000
32-2113	32-2113T	Amber	Neon	125	1/3W	25,000
35-2113	35-2113T	Amber	Neon	250	1/3W	25,000
32G1-2113	32G1-2113T	Amber	Incandescent	6	.20A	5,000
32G3-2113	32G3-2113T	Amber	Incandescent	14	.10A	10,000
32G18-2113	32G18-2113T	Amber	Incandescent	28	.04A	7,000
32-2114	32-2114T	Blue	Neon	125	1/3W	25,000
35-2114	35-2114T	Blue	Neon	250	1/3W	25,000
32G1-2114	32G1-2114T	Blue	Incandescent	6	.20A	5,000
32G3-2114	32G3-2114T	Blue	Incandescent	14	.10A	10,000
32G18-2114	32G18-2114T	Blue	Incandescent	28	.04A	7,000
32-2115	32-2115T	White	Neon	125	1/3W	25,000
35-2115	35-2115T	White	Neon	250	1/3W	25,000
32G1-2115	32G1-2115T	White	Incandescent	6	.20A	5,000
32G3-2115	32G3-2115T	White	Incandescent	14	.10A	10,000
32G18-2115	32G18-2115T	White	Incandescent	28	.04A	7,000
32-2117	32-2117T	Clear	Neon	125	1/3W	25,000
35-2117	35-2117T	Clear	Neon	250	1/3W	25,000
32G1-2117	32G1-2117T	Clear	Incandescent	6	.20A	5,000
32G3-2117	32G3-2117T	Clear	Incandescent	14	.10A	10,000
32G18-2117	32G18-2117T	Clear	Incandescent	28	.04A	7,000